

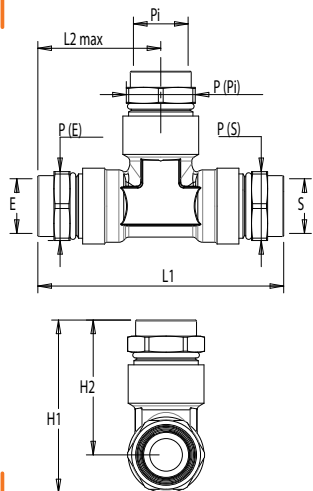

TÉ PLT FLEXICLIC



CALIBRE ÉQUIPÉ DU
SYSTÈME CLAP



























CARACTÉRISTIQUES TECHNIQUES

Normes : XP E 29-826



























Température : -20°C à +60°C

ENTRÉES/SORTIES			L1	L2 MAX	P	H1	H2	GAZ NATUREL PRESSION D'UTILISATION JUSQU'À	GPL PRESSION D'UTILISATION JUSQU'À	MARQUE	RÉF.
PLT (E)	PLT (Pi)	PLT (S)									
DN10	DN10	DN10	148	74	E 24 / Pi 24 / S 24	89	74	0,5 bar	2 bar		6101010
DN15	DN15	DN15	132	54	E 30 / Pi 30 / S 30	87	71	0,5 bar	2 bar		6151515
DN15	DN20	DN15	184	80	E 30 / Pi 36 / S 30	113	89	0,5 bar	2 bar		6152015
DN15	DN25	DN15	184	80	E 30 / Pi 42 / S 30	117	93	0,5 bar	2 bar		6152515
DN15	DN32	DN15	184	80	E 30 / Pi 50 / S 30	122	98	0,5 bar	-		6153215
DN15	DN40	DN15	212	94	E 30 / Pi 65 / S 30	157	123	0,5 bar	-		6154015
DN15	DN50	DN15	212	94	E 30 / Pi 65 / S 30	158	124	0,5 bar	-		6155015
DN20	DN15	DN15	133	57	E 36 / Pi 30 / S 30	93	73	0,5 bar	2 bar		6201515
DN20	DN15	DN20	134	57	E 36 / Pi 30 / S 36	93	73	0,5 bar	2 bar		6201520
DN20	DN20	DN20	134	57	E 36 / Pi 36 / S 36	96	76	0,5 bar	2 bar		6202020
DN20	DN25	DN15	181	80	E 36 / Pi 42 / S 30	117	93	0,5 bar	2 bar		6202515
DN20	DN25	DN20	180	80	E 36 / Pi 42 / S 36	117	93	0,5 bar	2 bar		6202520
DN20	DN32	DN15	181	80	E 36 / Pi 50 / S 30	122	98	0,5 bar	-		6203215



























TÉ PLT FLEXICLIC

ENTRÉES/SORTIES			L1	L2 MAX	P	H1	H2	GAZ NATUREL PRESSION D'UTILISATION JUSQU'À	GPL PRESSION D'UTILISATION JUSQU'À	MARQUE	RÉF.
PLT (E)	PLT (PI)	PLT (S)									
DN20	DN32	DN20	180	80	E 36 / Pi 50 / S 36	122	98	0,5 bar	-		6203220
DN20	DN40	DN15	212	96	E 36 / Pi 65 / S 30	157	123	0,5 bar	-		6204015
DN20	DN40	DN20	212	96	E 36 / Pi 65 / S 36	157	123	0,5 bar	-		6204020
DN20	DN50	DN15	212	96	E 36 / Pi 75 / S 30	158	124	0,5 bar	-		6205015
DN20	DN50	DN20	212	96	E 36 / Pi 75 / S 36	158	124	0,5 bar	-		6205020
DN25	DN15	DN15	186	95	E 42 / Pi 30 / S 30	116	90	0,5 bar	2 bar		6251515
DN25	DN15	DN20	145	78	E 42 / Pi 30 / S 36	96	73	0,5 bar	2 bar		6251520
DN25	DN15	DN25	156	78	E 42 / Pi 30 / S 42	96	73	0,5 bar	2 bar		6251525
DN25	DN20	DN15	186	95	E 42 / Pi 36 / S 30	115	89	0,5 bar	2 bar		6252015
DN25	DN20	DN20	145	78	E 42 / Pi 36 / S 36	96	73	0,5 bar	2 bar		6252020
DN25	DN20	DN25	190	95	E 42 / Pi 36 / S 42	115	89	0,5 bar	2 bar		6252025
DN25	DN25	DN15	186	95	E 42 / Pi 42 / S 30	119	93	0,5 bar	2 bar		6252515
DN25	DN25	DN20	185	95	E 42 / Pi 42 / S 36	119	93	0,5 bar	2 bar		6252520
DN25	DN25	DN25	156	78	E 42 / Pi 42 / S 42	101	78	0,5 bar	2 bar		6252525
DN25	DN32	DN15	186	95	E 42 / Pi 50 / S 30	124	98	0,5 bar	-		6253215
DN25	DN32	DN20	185	95	E 42 / Pi 50 / S 36	124	98	0,5 bar	-		6253220
DN25	DN32	DN25	190	95	E 42 / Pi 50 / S 42	124	98	0,5 bar	-		6253225
DN25	DN40	DN15	214	108	E 42 / Pi 65 / S 30	157	123	0,5 bar	-		6254015
DN25	DN40	DN20	214	108	E 42 / Pi 65 / S 36	157	123	0,5 bar	-		6254020
DN25	DN40	DN25	216	108	E 42 / Pi 65 / S 42	157	123	0,5 bar	-		6254025
DN25	DN50	DN15	214	108	E 42 / Pi 75 / S 30	158	124	0,5 bar	-		6255015
DN25	DN50	DN20	214	108	E 42 / Pi 75 / S 36	158	124	0,5 bar	-		6255020
DN25	DN50	DN25	216	108	E 42 / Pi 75 / S 42	158	124	0,5 bar	-		6255025
DN32	DN15	DN15	191	99	E 50 / Pi 30 / S 30	120	90	0,5 bar	-		6321515
DN32	DN15	DN20	190	99	E 50 / Pi 30 / S 36	120	90	0,5 bar	-		6321520
DN32	DN15	DN25	194	99	E 50 / Pi 30 / S 42	120	90	0,5 bar	-		6321525

TÉ PLT FLEXICLIC

ENTRÉES/SORTIES			L1	L2 MAX	P	H1	H2	GAZ NATUREL PRESSION D'UTILISATION JUSQU'À	GPL PRESSION D'UTILISATION JUSQU'À	MARQUE	RÉF.
PLT (E)	PLT (PI)	PLT (S)									
DN32	DN15	DN32	198	99	E 50 / Pi 30 / S 50	120	90	0,5 bar	-		6321532
DN32	DN20	DN15	191	99	E 50 / Pi 36 / S 30	119	89	0,5 bar	-		6322015
DN32	DN20	DN20	190	99	E 50 / Pi 36 / S 36	119	89	0,5 bar	-		6322020
DN32	DN20	DN25	194	99	E 50 / Pi 36 / S 42	119	89	0,5 bar	-		6322025
DN32	DN20	DN32	198	99	E 50 / Pi 36 / S 50	119	89	0,5 bar	-		6322032
DN32	DN25	DN15	191	99	E 50 / Pi 42 / S 30	123	93	0,5 bar	-		6322515
DN32	DN25	DN20	190	99	E 50 / Pi 42 / S 36	123	93	0,5 bar	-		6322520
DN32	DN25	DN25	194	99	E 50 / Pi 42 / S 42	123	93	0,5 bar	-		6322525
DN32	DN25	DN32	198	99	E 50 / Pi 42 / S 50	123	93	0,5 bar	-		6322532
DN32	DN32	DN15	191	99	E 50 / Pi 50 / S 30	128	98	0,5 bar	-		6323215
DN32	DN32	DN20	190	99	E 50 / Pi 50 / S 36	128	98	0,5 bar	-		6323220
DN32	DN32	DN25	194	99	E 50 / Pi 50 / S 42	128	98	0,5 bar	-		6323225
DN32	DN32	DN32	198	99	E 50 / Pi 50 / S 50	128	98	0,5 bar	-		6323232
DN32	DN40	DN15	211	105	E 50 / Pi 65 / S 30	157	123	0,5 bar	-		6324015
DN32	DN40	DN20	211	105	E 50 / Pi 65 / S 36	157	123	0,5 bar	-		6324020
DN32	DN40	DN25	213	105	E 50 / Pi 65 / S 42	157	123	0,5 bar	-		6324025
DN32	DN50	DN15	211	105	E 50 / Pi 75 / S 30	158	124	0,5 bar	-		6325015
DN32	DN50	DN20	211	105	E 50 / Pi 75 / S 36	158	124	0,5 bar	-		6325020
DN32	DN50	DN25	213	105	E 50 / Pi 75 / S 42	158	124	0,5 bar	-		6325025
DN32	DN50	DN32	210	105	E 50 / Pi 75 / S 50	158	124	0,5 bar	-		6325032
DN40	DN15	DN15	229	123	E 65 / Pi 30 / S 30	143	106	0,5 bar	-		6401515
DN40	DN15	DN20	229	123	E 65 / Pi 30 / S 36	143	106	0,5 bar	-		6401520
DN40	DN15	DN25	231	123	E 65 / Pi 30 / S 42	143	106	0,5 bar	-		6401525
DN40	DN15	DN32	228	123	E 65 / Pi 30 / S 50	143	106	0,5 bar	-		6401532
DN40	DN15	DN40	246	123	E 65 / Pi 30 / S 65	143	106	0,5 bar	-		6401540
DN40	DN20	DN15	229	123	E 65 / Pi 36 / S 30	143	106	0,5 bar	-		6402015

TÉ PLT FLEXICLIC

ENTRÉES/SORTIES			L1	L2 MAX	P	H1	H2	GAZ NATUREL PRESSION D'UTILISATION JUSQU'À	GPL PRESSION D'UTILISATION JUSQU'À	MARQUE	RÉF.
PLT (E)	PLT (PI)	PLT (S)									
DN40	DN20	DN20	229	123	E 65 / Pi 36 / S 36	143	106	0,5 bar	-		6402020
DN40	DN20	DN25	231	123	E 65 / Pi 36 / S 42	143	106	0,5 bar	-		6402025
DN40	DN20	DN32	228	123	E 65 / Pi 36 / S 50	143	106	0,5 bar	-		6402032
DN40	DN20	DN40	246	123	E 65 / Pi 36 / S 65	143	106	0,5 bar	-		6402040
DN40	DN25	DN15	229	123	E 65 / Pi 42 / S 30	145	108	0,5 bar	-		6402515
DN40	DN25	DN20	229	123	E 65 / Pi 42 / S 36	145	108	0,5 bar	-		6402520
DN40	DN25	DN25	231	123	E 65 / Pi 42 / S 42	145	108	0,5 bar	-		6402525
DN40	DN25	DN32	228	123	E 65 / Pi 42 / S 50	145	108	0,5 bar	-		6402532
DN40	DN25	DN40	246	123	E 65 / Pi 42 / S 65	145	108	0,5 bar	-		6402540
DN40	DN32	DN15	229	123	E 65 / Pi 50 / S 30	142	105	0,5 bar	-		6403215
DN40	DN32	DN20	229	123	E 65 / Pi 50 / S 36	142	105	0,5 bar	-		6403220
DN40	DN32	DN25	231	123	E 65 / Pi 50 / S 42	142	105	0,5 bar	-		6403225
DN40	DN32	DN32	228	123	E 65 / Pi 50 / S 50	142	105	0,5 bar	-		6403232
DN40	DN32	DN40	246	123	E 65 / Pi 50 / S 65	142	105	0,5 bar	-		6403240
DN40	DN40	DN15	229	123	E 65 / Pi 65 / S 30	160	123	0,5 bar	-		6404015
DN40	DN40	DN20	229	123	E 65 / Pi 65 / S 36	160	123	0,5 bar	-		6404020
DN40	DN40	DN25	231	123	E 65 / Pi 65 / S 42	160	123	0,5 bar	-		6404025
DN40	DN40	DN32	228	123	E 65 / Pi 65 / S 50	160	123	0,5 bar	-		6404032
DN40	DN40	DN40	246	123	E 65 / Pi 65 / S 65	160	123	0,5 bar	-		6404040
DN40	DN50	DN15	229	123	E 65 / Pi 75 / S 30	161	124	0,5 bar	-		6405015
DN40	DN50	DN20	229	123	E 65 / Pi 75 / S 36	161	124	0,5 bar	-		6405020
DN40	DN50	DN25	231	123	E 65 / Pi 75 / S 42	161	124	0,5 bar	-		6405025
DN40	DN50	DN32	228	123	E 65 / Pi 75 / S 50	161	124	0,5 bar	-		6405032
DN40	DN50	DN40	246	123	E 65 / Pi 75 / S 65	161	124	0,5 bar	-		6405040
DN50	DN15	DN15	230	124	E 75 / Pi 30 / S 30	149	106	0,5 bar	-		6501515
DN50	DN15	DN20	230	124	E 75 / Pi 30 / S 36	149	106	0,5 bar	-		6501520

TÉ PLT FLEXICLIC

ENTRÉES/SORTIES			L1	L2 MAX	P	H1	H2	GAZ NATUREL PRESSION D'UTILISATION JUSQU'À	GPL PRESSION D'UTILISATION JUSQU'À	MARQUE	RÉF.
PLT (E)	PLT (Pi)	PLT (S)									
DN50	DN15	DN25	232	124	E 75 / Pi 30 / S 42	149	106	0,5 bar	-		6501525
DN50	DN15	DN32	229	124	E 75 / Pi 30 / S 50	149	106	0,5 bar	-		6501532
DN50	DN15	DN40	247	124	E 75 / Pi 30 / S 65	149	106	0,5 bar	-		6501540
DN50	DN15	DN50	248	124	E 75 / Pi 30 / S 75	149	106	0,5 bar	-		6501550
DN50	DN20	DN15	230	124	E 75 / Pi 36 / S 30	149	106	0,5 bar	-		6502015
DN50	DN20	DN20	230	124	E 75 / Pi 36 / S 36	149	106	0,5 bar	-		6502020
DN50	DN20	DN25	232	124	E 75 / Pi 36 / S 42	149	106	0,5 bar	-		6502025
DN50	DN20	DN32	229	124	E 75 / Pi 36 / S 50	149	106	0,5 bar	-		6502032
DN50	DN20	DN40	247	124	E 75 / Pi 36 / S 65	149	106	0,5 bar	-		6502040
DN50	DN20	DN50	248	124	E 75 / Pi 36 / S 75	149	106	0,5 bar	-		6502050
DN50	DN25	DN15	230	124	E 75 / Pi 42 / S 30	151	108	0,5 bar	-		6502515
DN50	DN25	DN20	230	124	E 75 / Pi 42 / S 36	151	108	0,5 bar	-		6502520
DN50	DN25	DN25	232	124	E 75 / Pi 42 / S 42	151	108	0,5 bar	-		6502525
DN50	DN25	DN32	229	124	E 75 / Pi 42 / S 50	151	108	0,5 bar	-		6502532
DN50	DN25	DN40	247	124	E 75 / Pi 42 / S 65	151	108	0,5 bar	-		6502540
DN50	DN25	DN50	248	124	E 75 / Pi 42 / S 75	151	108	0,5 bar	-		6502550
DN50	DN32	DN15	230	124	E 75 / Pi 50 / S 30	148	105	0,5 bar	-		6503215
DN50	DN32	DN20	230	124	E 75 / Pi 50 / S 36	148	105	0,5 bar	-		6503220
DN50	DN32	DN25	232	124	E 75 / Pi 50 / S 42	148	105	0,5 bar	-		6503225
DN50	DN32	DN32	229	124	E 75 / Pi 50 / S 50	148	105	0,5 bar	-		6503232
DN50	DN32	DN40	247	124	E 75 / Pi 50 / S 65	148	105	0,5 bar	-		6503240
DN50	DN32	DN50	248	124	E 75 / Pi 50 / S 75	148	105	0,5 bar	-		6503250
DN50	DN40	DN15	230	124	E 75 / Pi 65 / S 30	166	123	0,5 bar	-		6504015
DN50	DN40	DN20	230	124	E 75 / Pi 65 / S 36	166	123	0,5 bar	-		6504020
DN50	DN40	DN25	232	124	E 75 / Pi 65 / S 42	166	123	0,5 bar	-		6504025
DN50	DN40	DN32	229	124	E 75 / Pi 65 / S 50	166	123	0,5 bar	-		6504032
DN50	DN40	DN40	247	124	E 75 / Pi 65 / S 65	166	123	0,5 bar	-		6504040
DN50	DN40	DN50	248	124	E 75 / Pi 65 / S 75	166	123	0,5 bar	-		6504050
DN50	DN50	DN15	230	124	E 75 / Pi 75 / S 30	167	124	0,5 bar	-		6505015
DN50	DN50	DN20	230	124	E 75 / Pi 75 / S 36	167	124	0,5 bar	-		6505020
DN50	DN50	DN25	232	124	E 75 / Pi 75 / S 42	167	124	0,5 bar	-		6505025
DN50	DN50	DN32	229	124	E 75 / Pi 75 / S 50	167	124	0,5 bar	-		6505032
DN50	DN50	DN40	247	124	E 75 / Pi 75 / S 65	167	124	0,5 bar	-		6505040
DN50	DN50	DN50	248	124	E 75 / Pi 75 / S 75	167	124	0,5 bar	-		6505050